

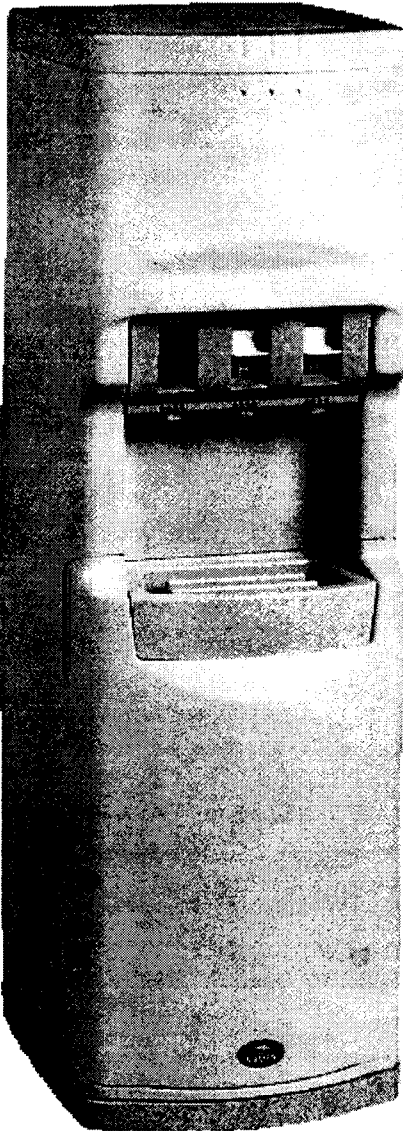

## Illustrated Parts Breakdown

Models:

**POU1AQHK-D100 &  
POU1AQK-D100**



### SPECIFICATIONS:

#### Models: POU1AQHK-D100

Voltage	115VAC±10%/1 PH/60 Hertz
Size	43 1/2"H, 13 1/2"W, 16"D
Shipping Weight (Approx)	56 lbs
Cold Water Capacity*	.5 GPH
Compressor	1/20 hp
Compressor (Full Load)	5.5 amps
Refrigerant	134a
Refrigerant Charge	1.9 OZ

#### Model: POU1AQK-D100

Voltage	115VAC±10%/1 PH/60 Hertz
Size	43 1/2"H, 13 1/2"W, 16"D
Shipping Weight (Approx)	53 lbs.
Cold Water Capacity*	.6 GPH
Compressor	1/20 hp
Compressor (Full Load)	1.2 amps
Refrigerant	134a
Refrigerant Charge	1.9 OZ

\*A.R.I. Ratings: Room Temperature 90°F; Supply Water Temperature 80°F; Drinking Water Temperature 50°F.

Specifications subject to change without notice.

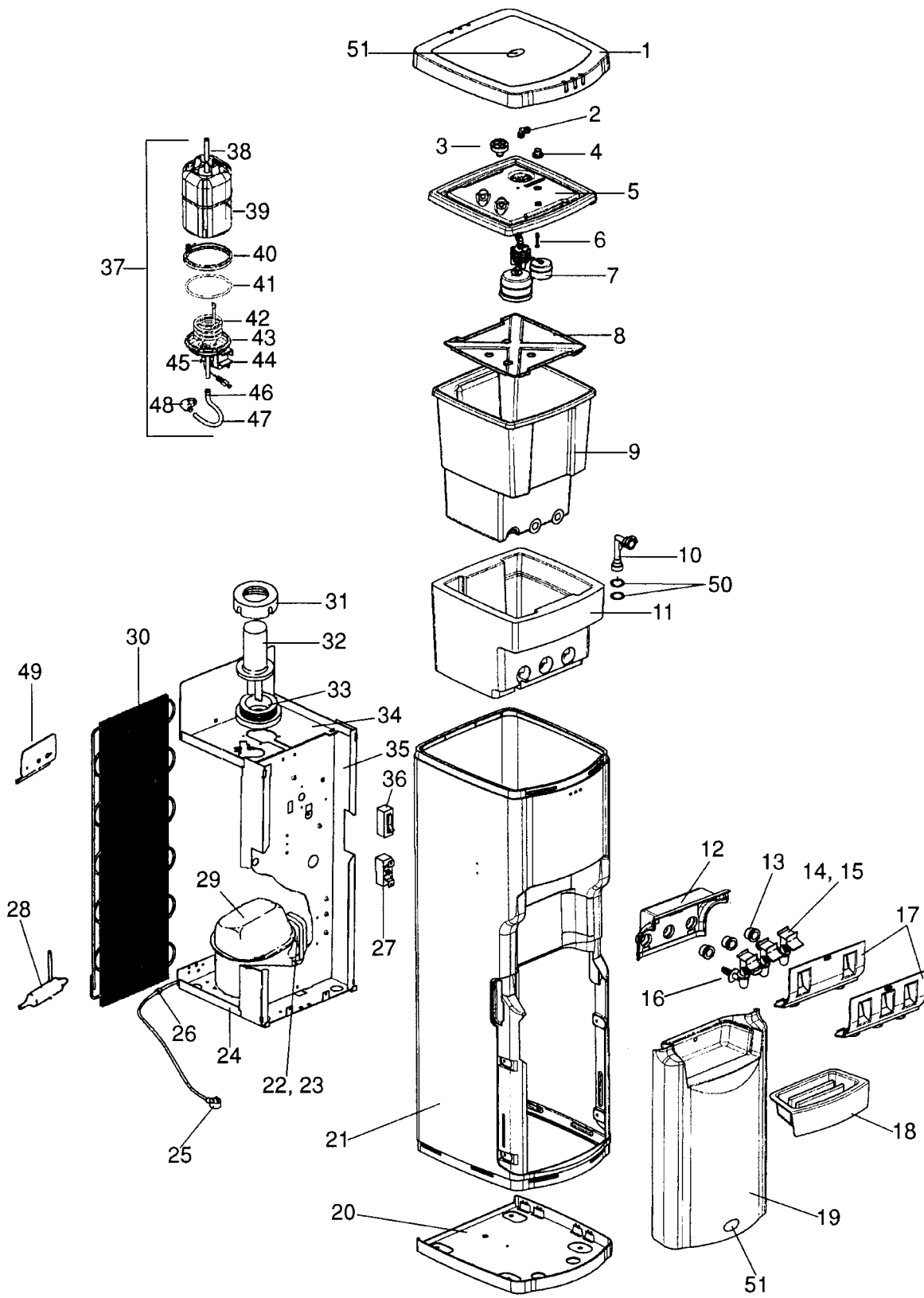

Item#	Description	POU1AQK-D100	POU1AQHK-D100
1	Top.....	033479-001	033749-001
2	Fitting, JG Elbow.....	028481-001	028481-001
3	Air Filter.....	031823-001	031823-001
4	Reset Button.....	033286-001	033286-001
5	Lid.....	033222-001	033222-001
6	Reset Arm.....	033285-001	033285-001
7	Mechanical Float Assy.....	033287-001	033287-001
8	Baffle.....	033221-001	033221-001
9	Reservoir Assy.....	033220-001	033210-001
10	Hot Tank Manifold.....	N/A	033395-001
11	Insulation.....	033228-001	033228-002
12	Valve Plate.....	033225-002	033225-004
13	Faucet Gasket.....	031429-001	031429-001
14	Cold Faucet & Lever Assy.....	030499-007	030499-007
15	Cook Faucet & Lever Assy.....	030499-007	030499-007
16	Hot Faucet & Lever Assy.....	N/A	030499-017
17	Valve Cover.....	030862-004	030862-003
18	Drip Tray.....	030864-002	030864-002
19	Door Assy.....	033478-001	033478-001
20	Base, Cabinet.....	033198-001	033198-001
21	Cabinet Assy.....	033200-001	033200-001
22	Relay.....	025817-007	025817-007
23	Overload.....	028707-007	028707-007
24	Base.....	020513-002	020513-002
25	Service Cord .....	026540-047	026540-047
26	Strain Relief Bushing.....	019008	019008
27	Cold Control.....	027040-030	027040-030
28	Filter Drier.....	033380-002	033380-002
29	Compressor (includes 22 & 23).....	031530-008	031530-008
30	Condenser.....	028357-003	028357-003
31	Collar, Probe.....	031368-001	031368-001
32	Probe Assy.....	031539-002	031539-002
33	Retainer Ring, Probe.....	033169-001	033169-001
34	Shelf.....	033204-001	033204-001
35	Column Support.....	033203-001	033203-001
36	Hot Tank Switch.....	N/A	032840-001
37	Hot Tank Assy.....	N/A	032946-005
38	Body & Head Assy.....	N/A	032822-002
39	Insulation, Hot Tank.....	N/A	032734-001
40	Clamp, V Coupling.....	N/A	032729-001
41	O-Ring, Heater Pan.....	N/A	030858-402
42	Element, Hot Tank.....	N/A	032487-001
43	Lower Hot Tank Assy.....	N/A	032823-002
44	Hot Thermostat.....	N/A	032732-001
45	Heat Limiter.....	N/A	032731-002
46	Tube Clamp.....	N/A	032816-001
47	Extension Tube.....	N/A	033072-004
48	Drain Valve.....	N/A	032817-001
49	Handle.....	029562-001	029562-001
50	O-Ring, Hot Tank Manifold .....	030858-212(2)	030858-212(2)
51	Insert, OASIS®.....	031434-003	031434-003
<b>Parts Not Shown</b>			
	Cook Tube.....	033397-001	033397-001
	Hot Tube.....	N/A	033397-001
	FTG, JG Bulkhead.....	028913-003	028913-003

# ELECTRICAL DIAGRAM

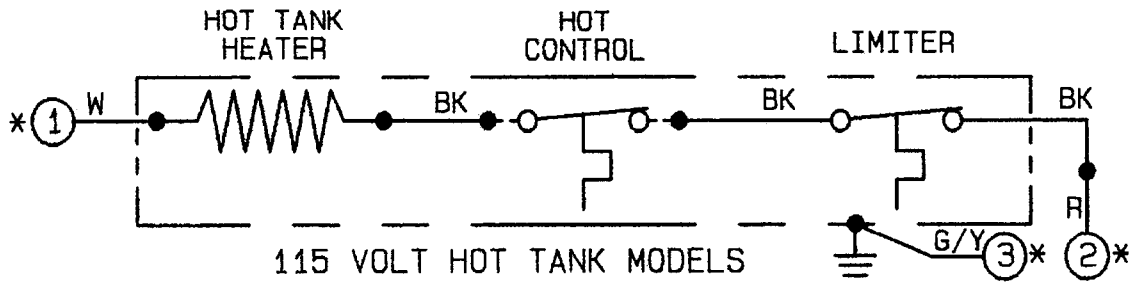

COMPRESSOR WITH  
INTERNAL OVERLOAD  
SHOWN.  
COMPRESSOR  
MAY HAVE  
EXTERNAL OVERLOAD

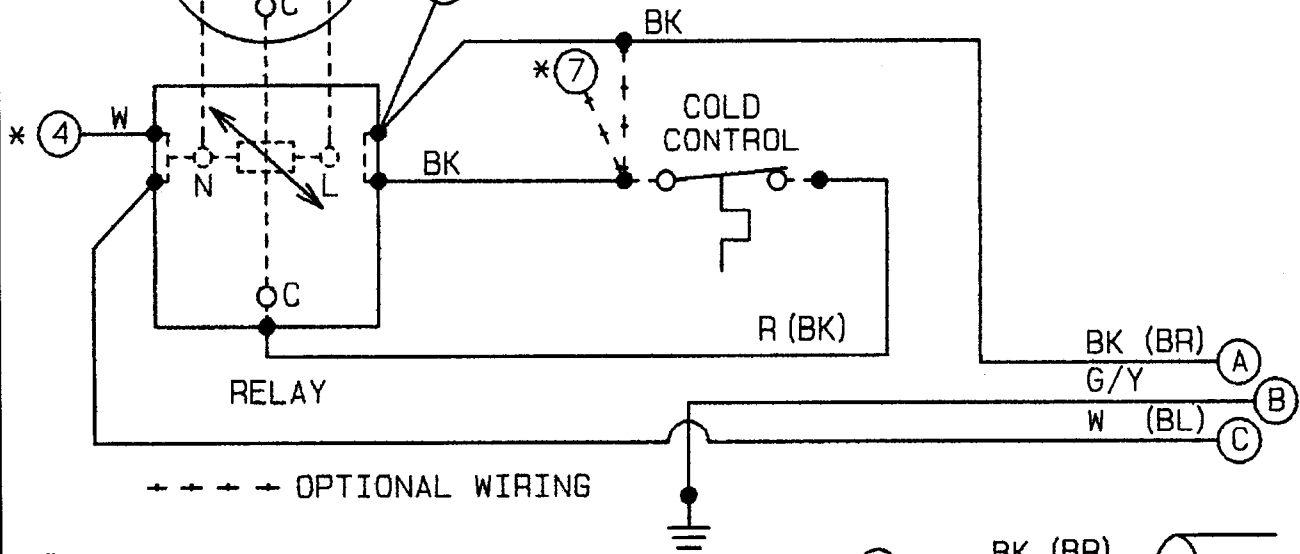
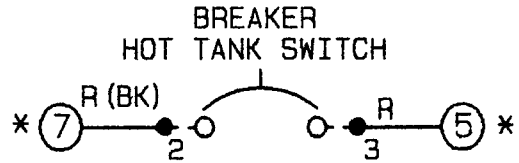
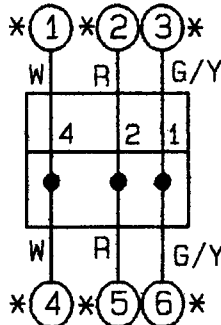
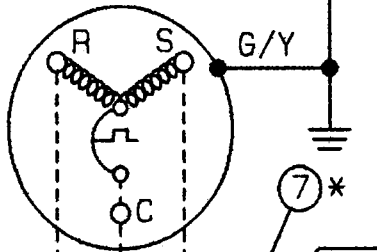

( ) -ALT. COLOR

● -TERMINAL CONNECTION

\* NOTE: BALLOONED NUMBERS ARE ONLY APPLICABLE TO HOT MODEL UNITS.

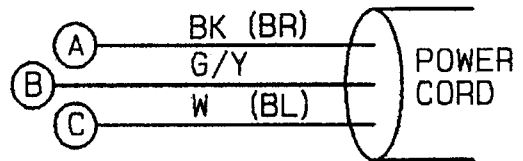

115 VOLT MODELS

## OASIS Corporation

265 N Hamilton Rd • PO Box 13150 • Columbus OH 43213  
614/861-1350 • 614/861-0231 Fax